

## Type NS-SCBC215 Stackable Crane Bin

The types NS-SCBC215 Stackable Crane Bin has been designed with space saving contours to allow the bins to interlock for transport and storage and is suitable for all waste products. All bins are fitted with 2-way entry fork pockets allowing emptying by rotating Forklift, or positive handling on uneven ground. 4 Crane Lugs are fitted along with upending lugs for Crane emptying.

The type NS-SCBC215 bins are available with either a Safe Working Load of 1000kg (made from 3mm sheet), or with a Safe Working Load of 2000kg (made from 5mm plate), and range in sizes from 0.75 – 1.80 cubic metre capacities. These bins are available in either enamel painted over primed steel or H.D. Galvanised finish.

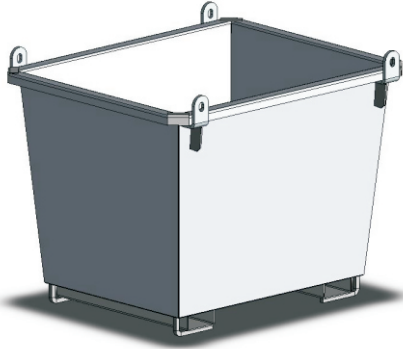

(Type NS-SCBC215 standard model shown)

### SPECIFICATIONS:

- Pocket size 165 x 70mm
- Pocket Centres – refer Table
- Safe Working Load – refer Table
- Unit Weight – refer Table
- Volume Capacity – refer Table
- HCG 600mm

### OPTIONS:

- 4-way Pockets, Wheels, Lid
- Drain Valve & Strainer

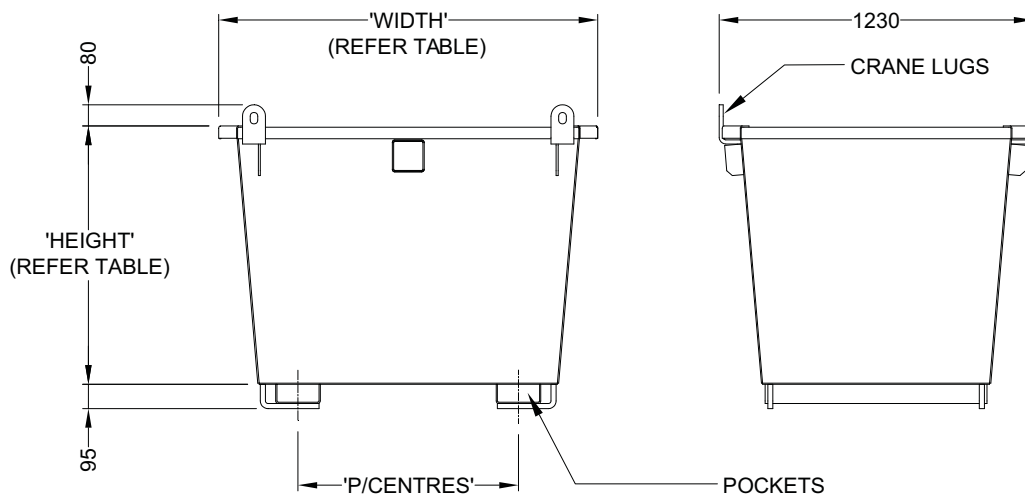

Capacity	SWL	Length	Height	Width	Pocket Size (mm)	P/Centres	Unit Weight
1.25 cu m	2000kg	1210mm	1095mm	1500mm	165 x 70	865mm	290kg